

TWN4 MULTITECH PANEL LEGIC 42*

125kHz/134.2kHz & 13.56MHz Contactless Reader/Writer

*previously known as TWN4 PANEL LEGIC NFC



Front View









Rear View, Panel not included

Elatec's Vending Machine Kit consists of the TWN4 LEGIC Core Module with an attached antenna (TWN4 Panel LEGIC NFC OEM PCB) in a black rectangular rugged plastic housing. It is ideal for use in vending, kiosk or gaming machines. The housing is rated IP65 from outside and therefore ideal for outdoor usage e.g. in parking systems, EV Chargers etc. The kit comes fully mounted with an USB Type A or a RS232 cable, which can be easily changed due to the flexible connector pinout.

Elatec's TWN4 Panel LEGIC NFC allows users to read and write to almost any 125kHz/134.2kHz and 13.56MHz tags and/or labels – it supports all major transponders from various suppliers like ATMEL, EM, ST, MIFARE NXP, TI, HID, LEGIC, etc. and ISO standards like ISO14443A including ISO14443A-4 (T=CL), ISO14443B including ISO14443B-4 (T=CL), ISO15693, ISO18092 / ECMA-340 (NFC).

Special Features:

- Powerful SDK for writing Apps which are executed directly on the reader
- Infield Upgradeable
- Direct chip-commands support
- CCID and PC/SC 2.0¹⁾
- Interfaces:
USB, RS232, Serial (logical level 3.3V, CMOS 5V tolerant), I²C, SPI²⁾, Clock/Data³⁾, Wiegand³⁾, CAN²⁾³⁾, 1-Wire²⁾
- Dedicated expansion bus for connection of LCD, mass storage, etc.
- 8 GPIOs
- Step Model Data on request

Technical Data ⁴⁾										
Frequency	125kHz, 134.2kHz (LF) / 13.56MHz (HF)									
Antenna	Aircoil (125KHz) and Aircoil PCB (13.56MHz)									
Housing	Plastic, black									
Power Supply	4.3V..5.5V via USB or RS232; RS232 requires external power supply; via connector CNB 3.3V +/- 5%									
Current Consumption	RF field on: 140mA typically									
Temperature Range	Operating: -25°C up to +80°C (-13°F up to +176°F) Storage: -45°C up to +85°C (-49°F up to +185°F)									
Read- / Write Distance	Up to 100mm / 4inch, depending on antenna and tag									
HOST Interface	USB, RS232, serial (logical level 3.3V, CMOS 5V tolerant), I ² C, SPI ²⁾ , Clock/Data ³⁾ , Wiegand ³⁾ , CAN ²⁾³⁾ , 1-Wire ²⁾									
OS Support	Windows XP, Vista, Embedded CE ²⁾ , 7(32-/64-bit), 8, 8.1, 10, Linux, Android, iOS ²⁾ , MAC OS X ²⁾									
Transmission Speed	HOST: USB: Full speed (12Mbit) – RS232: up to 115.200baud AIR: up to 424kbit/s									
Modes of Operation	<ul style="list-style-type: none"> USB keyboard emulation – USB virtual COM port – Transparent (direct chip-commands support) CCID and PC/SC 2.01¹⁾ 									
Relative Humidity	5% to 95% non-condensing									
Supported Transponders	<p>Standard</p> <ul style="list-style-type: none"> 125kHz / 134.2kHz: 4100, 4102, 4200¹⁰⁾, 4050, 4150, 4450, 4550, AWID, CASI-RUSCO, HITAG 1¹¹⁾, HITAG 2¹¹⁾, HITAG S¹¹⁾, Keri, Miro, Pyramid, TIRIS/HDX, UNIQUE, FDX-B, Q5, TITAN, T55x7, ZODIAC Optionally, in consideration: 4305, Cardax, IDTECK 13.56MHz: LEGIC Advant, LEGIC Prime ISO14443 A+B: compatible to part 4, MIFARE DESFire EV1, MIFARE Plus, MIFARE SmartMX, my-d move⁷⁾, PayPass, MIFARE Classic EV1⁹⁾, MIFARE Ultralight EV1⁹⁾, MIFARE Ultralight C, NTAG2xx⁹⁾, HID iCLASS⁵⁾ ISO15693: EM4035⁷⁾, Tag-it, my-d vicinity⁷⁾, ICODE SLI, M24LR16/64, PicoPass⁵⁾, HID iCLASS⁵⁾ ISO18092 / NFC: NFCIP-1: NFC Forum Tag Type 2-4, Sony FeliCa⁶⁾ <p>Version P</p> <p>Standard+Cotag,G-Prox⁸⁾, HID (Prox,Prox II,Duo Prox II,ISO Prox II,Micro Prox,ProxKey),Honeywell NexWatch,Indala,ioProx</p>									
Certifications	CE, R&TTE, RoHS-II compliant									
MTBF	500.000 hours									
Order Code	<table border="0"> <tr> <td>Standard: T4PO-B</td> <td>USB (0.45m/17.7inch)</td> <td>RS232 (2.0m/78.7inch)</td> </tr> <tr> <td>Version P: T4PO-B-P</td> <td>Standard: T4PA-BB6B</td> <td>T4PA-BR2B</td> </tr> <tr> <td></td> <td>Version P: T4PA-BB6B -P</td> <td>T4PA-BR2B-P</td> </tr> </table>	Standard: T4PO-B	USB (0.45m/17.7inch)	RS232 (2.0m/78.7inch)	Version P: T4PO-B-P	Standard: T4PA-BB6B	T4PA-BR2B		Version P: T4PA-BB6B -P	T4PA-BR2B-P
Standard: T4PO-B	USB (0.45m/17.7inch)	RS232 (2.0m/78.7inch)								
Version P: T4PO-B-P	Standard: T4PA-BB6B	T4PA-BR2B								
	Version P: T4PA-BB6B -P	T4PA-BR2B-P								
Description	<table border="0"> <tr> <td>TWN4 MultiTech Panel LEGIC 42 OEM PCB (46x56x38mm) (1.81x2.20x1.50inch)</td> <td></td> <td>TWN4 MultiTech Panel LEGIC 42 OEM PCB including housing/cable</td> <td></td> </tr> </table>	TWN4 MultiTech Panel LEGIC 42 OEM PCB (46x56x38mm) (1.81x2.20x1.50inch)		TWN4 MultiTech Panel LEGIC 42 OEM PCB including housing/cable						
TWN4 MultiTech Panel LEGIC 42 OEM PCB (46x56x38mm) (1.81x2.20x1.50inch)		TWN4 MultiTech Panel LEGIC 42 OEM PCB including housing/cable								
Weight	Approx. 15g	Approx. 150g								

¹⁾In Preparation ²⁾On Request Only ³⁾External Interface Required ⁴⁾Target Specification ⁵⁾UID Only ⁶⁾Encryption Not Supported ⁷⁾UID/PUP! Only, Read/Write On Request ⁸⁾Hash Value Only ⁹⁾r/w enhanced security features on request

Dimensions

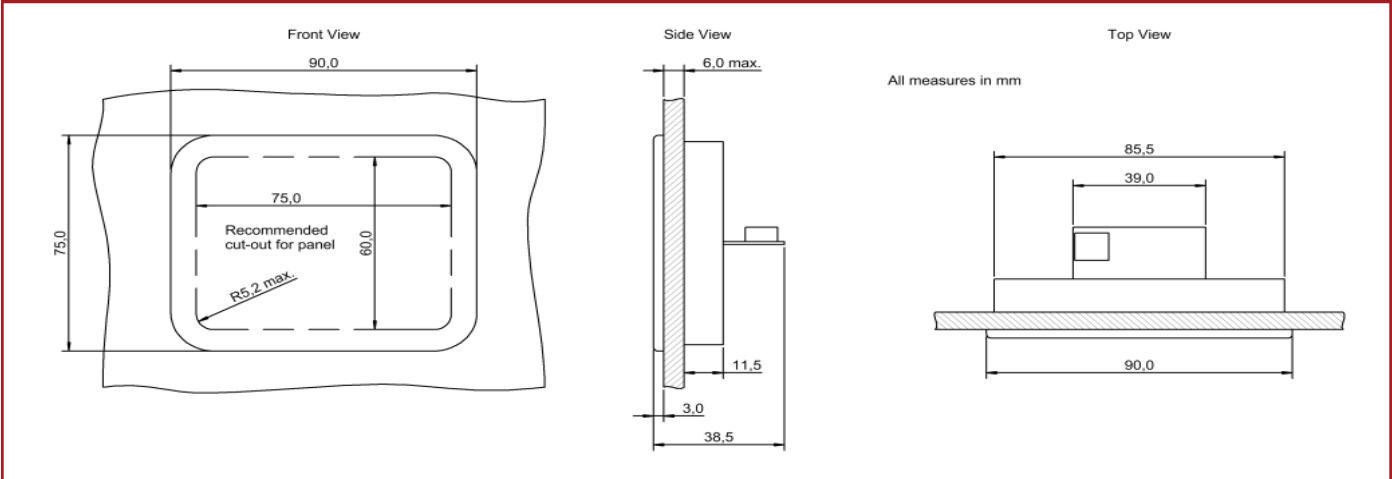

Elatec reserves the right to change any information or data in this document without prior notice. The distribution and the update of this document is not controlled. Elatec declines all responsibility for the use of product with any other specifications but the ones mentioned above. Any additional requirement for a specific customer application has to be validated by the customer himself at his own responsibility. Where application information is given, it is only advisory and does not form part of the specification. Disclaimer: All names are registered trademarks. © 2015 Elatec GmbH – DocRev9 – 08/2015